

Assembly Instructions For FM372 (E) 5/22/2012

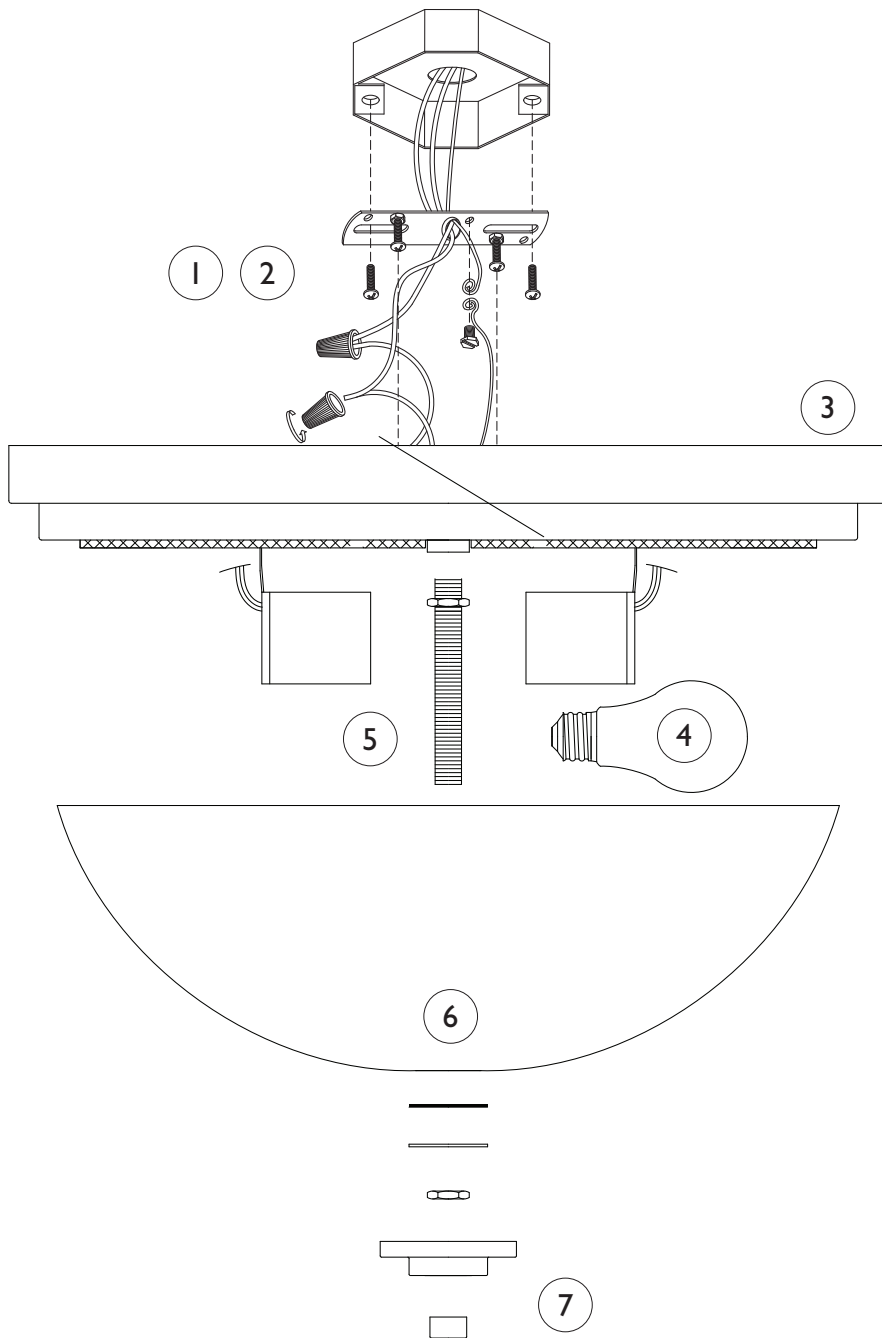

IMPORTANT
TURN OFF THE POWER AT THE MAIN FUSE OR
CIRCUIT BREAKER BOX
BEFORE STARTING INSTALLATION

Carefully unpack and identify all parts before assembly. Bulbs not included.

1. Install mounting strap:
 - A. Gently pull supply wires out from outlet box.
 - B. Install mounting strap onto the outlet box using two screws supplied with outlet box. NOTE: The side with green grounding screw head must face away from the outlet box.
 - C. Spread electrical wires so that black wires are on one side of the outlet box and the white wires are on the other side.
2. Connect electrical wires:
 - A. Connect white fixture wire(s) to white supply wire from outlet box with wire connector. Connect black fixture wire(s) to black supply wire from outlet box with wire connector. NOTE: Black outlet box wire may be red, round and smooth and/or have copper conductor. White outlet box wire may be square and ridged and/or have a silver conductor.
 - B. Connect fixture ground wire (without plastic insulation) to ground wire from outlet box (usually with green insulation) with wire connector. Note: If there is no supply ground wire at outlet box then attach fixture ground wire securely onto green grounding screw located at mounting strap. IMPORTANT: Never connect ground wire to black or white supply wires (from outlet box).
3. Partially thread the two pan mounting screws into the mounting strap. Place the pan over the pan mounting screws through the key holes and twist the pan to lock in position. Then tighten the pan mounting screws until secure so the pan is flush with the ceiling.
4. Install light bulb (not included). See relamping label at socket area for type and maximum allowed wattage.
5. Screw the long threaded pipe into coupler located at bottom of socket assembly. Note correct position of threaded pipe at illustration.
6. Slip shade through the threaded pipe until it rests onto the bottom section of the pan. Then secure into position by fastening with flat washer and hex nut.
7. Install cover by fastening with finial.

FEISS®

EST. 1955