

Family: Plantation | Item No. 4887 BB/PZ

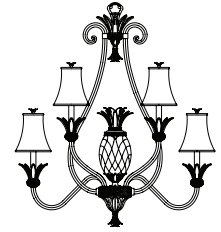

▼ start here

Drawing 1 - Fixture Assembly

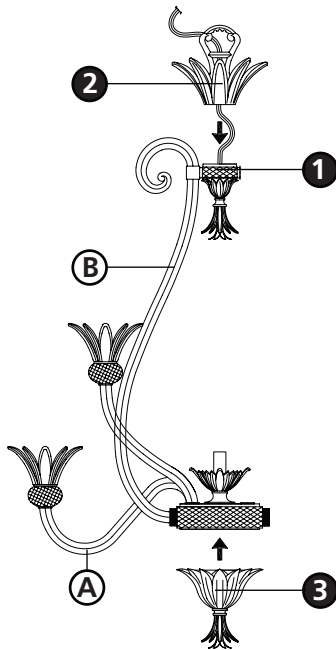

1

1. Find a clear area in which you can work.
2. Unpack fixture and glass from carton.
3. Carefully review instructions prior to assembly.

*** The construction of this fixture will be accomplished by first assembling the main body of the fixture, making all necessary electrical connections, hanging the fixture from the ceiling, and then installing the fixture glass.

SAFETY WARNING: READ WIRING AND GROUNDING INSTRUCTIONS (I.S. 18) AND ANY ADDITIONAL DIRECTIONS. TURN POWER SUPPLY OFF DURING INSTALLATION. IF NEW WIRING IS REQUIRED, CONSULT A QUALIFIED ELECTRICIAN OR LOCAL AUTHORITIES FOR CODE REQUIREMENTS.

2

1. Slip top crown (2) along wire and thread into top of main body assembly (1) - see **Drawing 1**.
2. Spread arms (A) of the fixture until they are equally spaced apart and located in between the uprights (B).
3. Please refer to the hanging instruction sheet (I.S. 19-50) provided to continue installation of this fixture. Then refer back to this sheet to install glass.

Drawing 2 - Glass Installation

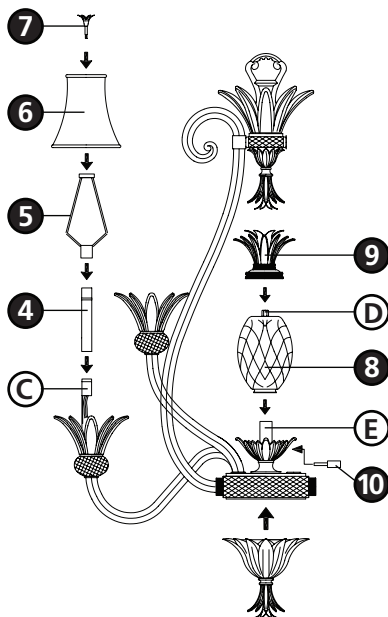

3

1. To install glass, slip candle sleeve (4) over socket (C) - see **Drawing 2**.
2. Slip harp (5) onto top of candle sleeve (4).
3. Attach shade (6) on the top of harp (5).
4. Thread finial (7) into top of harp (5) and tighten.
5. To assemble center glass (8), take top crown assembly (9) and thread into coupler (D).
6. Attach center glass (8) to center bobesche (E) by threading in stud screws (10).
Note: **DO NOT** use tools to tighten stud screws (10). Over tightening may cause glass damage.

5.30.08

Hanging instructions for fixtures that weight more than 50lbs

Drawing 1 - Fixture Assembly

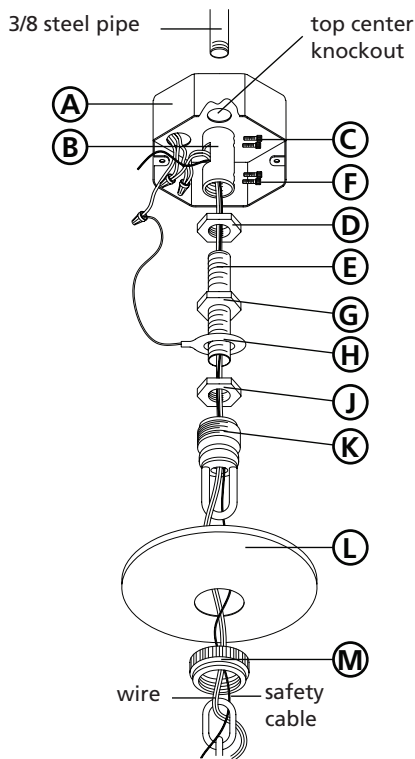

Drawing 2 - Installation Example

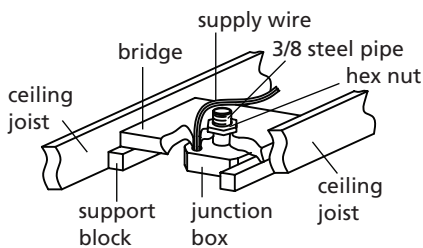

▼ start here

1

1. Shut off electrical current before starting. If the fixture you are replacing is turned on and off by a wall switch, simply turn the switch off. If not, remove the appropriate fuse (or open the circuit breakers) until the fixture is dead.

• **DO NOT RESTORE CURRENT - EITHER BY FUSE, BREAKER, OR SWITCH - UNTIL THE NEW FIXTURE IS COMPLETELY WIRED AND IN PLACE.**

2. Supply wires shall enter the outlet box (A) through any knockout EXCEPT the top center knockout - see **Drawing 1**.

2

1. Fixture is to be mounted by a 3/8 steel pipe with 3/8 -18 NPSM thread, 3/4" threads at both ends (not supplied). Pipe should be anchored to structure or bridging member with sufficient strength to support 4 times the fixtures weight - see **Drawing 2**.

2. Adjust pipe so 1/2" of 3/8 steel pipe extends into the junction box, at the center knockout.

3. Please refer to the back of this sheet to the **safety cable installation** instructions and **ONLY** complete steps 1 and 2 at this time.

3

1. Thread pipe coupler (B) onto protruding pipe inside outlet box. Secure in place by tightening allen head screw (C) - see **Drawing 1**.

2. Thread hexnut (D) onto threaded nipple (E). Thread nipple (E) into coupler (B). Secure in place by tightening hexnut (D) against coupler (B) and then tightening allen screw (F).

3. Thread hexnut (G) onto nipple (E). Slip ground wire loop (H) over nipple (E) and thread hexnut (J) onto nipple (E). **DO NOT** tighten hexnuts (G) and (J) at this time.

4. Thread screw collar loop (K). Adjust loop height so the half of the exterior thread on screw collar loop (K) is exposed when canopy (L) is held up to the ceiling.

4

1. Determine length of chain you will require. Attach one end of length of chain to fixture.

2. Slip threaded ring (M) and canopy (L) onto chain - see **Drawing 1**.

3. Attach fixture with chain to screw collar loop (K). Please get assistance, weight and size of fixture is difficult to manage alone.

4. Weave ground wire, supply wire, and safety cable through chain, up through center of screw collar loop (K), through center of nipple (E), and out the opening on the side of coupler (B).

5. Please refer back to safety cable installation instructions on the back of this sheet and complete step 4.

safety cable installation

WARNING: TO AVOID ELECTRICAL SHOCK, THIS SECTION OF THE INSTRUCTION SHEET IS FOR THE SOLE PURPOSE OF SAFETY CABLE INSTALLATION, AND IS NOT TO BE USED TO MAKE ANY ELECTRICAL CONNECTIONS.

- The safety cable must be attached to a ceiling joist or other permanent structure independent of the junction box

- Using a 1/8" dia., drill a pilot hole **(1)**. It must be drilled into the permanent structure or through the junction box on joist side where the safety cable is to be attached - see **Drawing 3**.
- Insert and thread a 1/4" hex head lag screw **(2)** (not included) into pilot hole.
- Continue back to previous I.S 19-50 to continue installation of this fixture.
- Wrap safety cable **(3)** around hex head lag screw **(2)** and tighten to secure cable - see **Drawing 3**.

SAFETY WARNING: READ WIRING AND GROUNDING INSTRUCTIONS (I.S. 18) AND ANY ADDITIONAL DIRECTIONS. TURN POWER SUPPLY OFF DURING INSTALLATION. IF NEW WIRING IS REQUIRED, CONSULT A QUALIFIED ELECTRICIAN OR LOCAL AUTHORITIES FOR CODE REQUIREMENTS.

Make electrical connections from supply wire to fixture lead wires. Refer to instruction sheet **(I.S. 18)** and follow all instructions to make all necessary wiring connections.

Drawing 3 - Safety Cable Installation

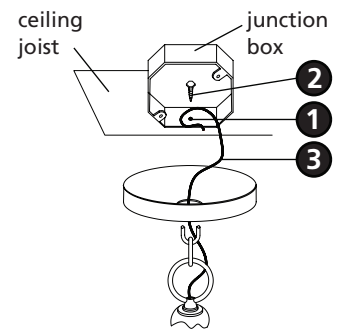

Drawing 1 - Flush Mount

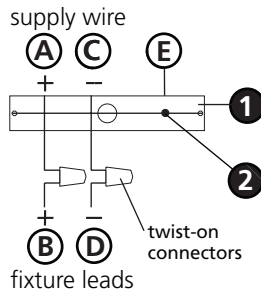

Drawing 2 - Chain Hung

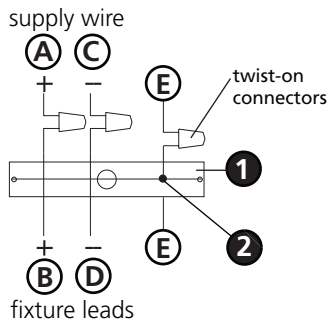

Drawing 3 - Post-Mount

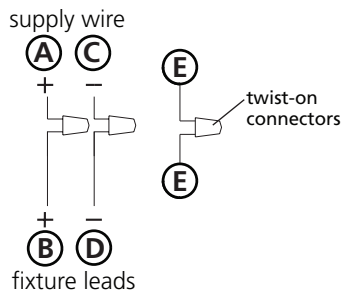

SAFETY WARNING: READ WIRING AND GROUNDING INSTRUCTIONS (I.S. 18) AND ANY ADDITIONAL DIRECTIONS. TURN POWER SUPPLY OFF DURING INSTALLATION. IF NEW WIRING IS REQUIRED, CONSULT A QUALIFIED ELECTRICIAN OR LOCAL AUTHORITIES FOR CODE REQUIREMENTS.

wiring instructions

Indoor Fixtures

1. Connect positive supply wire **(A)** (typically black or the smooth, unmarked side of the two-conductor cord) to positive fixture lead **(B)** with appropriately sized twist on connector - see **Drawings 1 or 2**.
2. Connect negative supply wire **(C)** (typically white or the ribbed, marked side of the two-conductor cord) to negative fixture lead **(D)**.
3. Please refer to the **grounding instructions** below to complete all electrical connections.

Outdoor Fixtures

1. Connect positive supply wire **(A)** (typically black or the smooth unmarked side of the two-conductor cord) to positive fixture lead **(B)** with appropriately sized twist on connector - see **Drawings 2 or 3**.
2. Connect negative supply wire **(C)** (typically white or the ribbed, marked side of the two-conductor cord) to negative fixture lead **(D)**.
3. Cover open end of connectors with silicone sealant to form a watertight seal.
 - If installing a wall mount fixture, use caulk to seal gaps between the fixture mounting plate (backplate) and the wall. This will help prevent water from entering the outlet box. If the wall surface is lap siding, use caulk and a fixture mounting platform specially.
4. Please refer to the **grounding instructions** below to complete all electrical connections.

grounding instructions

Flush Mount Fixtures

For positive grounding in a 3-wire electrical system, fasten the fixture ground wire **(E)** (typically copper or green plastic coated) to the fixture mounting strap **(1)** with the ground screw **(2)** - see **Drawing 1**.

Note: On straps for screw supported fixtures, first install the two mounting screws in strap. Any remaining tapped hole may be used for the ground screw.

Chain Hung Fixtures

Loop fixture ground wire **(E)** (typically copper or green plastic coated) under the head of the ground screw **(2)** on fixture mounting strap **(1)** and connect to the loose end of the fixture ground wire directly to the ground wire of the building system with appropriately sized twist-on connectors - see **Drawing 2**.

Post-Mount Fixtures

Connect fixture ground wire **(E)** (typically copper or green plastic coated) to power supply ground with appropriately sized twist-on connector inside post. Cover open end of connector with silicone sealant to form a watertight seal - see **Drawing 3**.