

Family: Hathaway | Item No. 3224 AN/OB

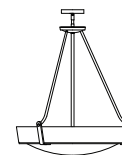

▼ start here

Drawing 1 - Fixture Assembly

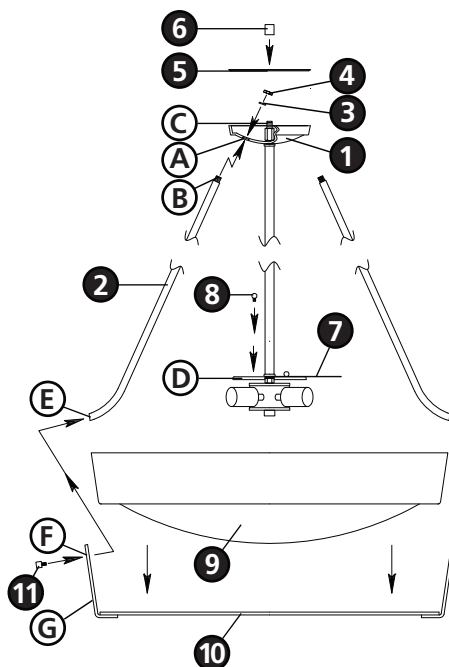

1

1. Find a clear area in which you can work.
2. Unpack fixture and glass from carton.
3. Carefully review instructions prior to assembly.

***** The construction of this fixture will be accomplished by first assembling the main body of the fixture, determining the length of stem required, mounting the mounting strap to the junction box, making all necessary electrical connections, hanging the fixture from the ceiling, and then installing the glass.**
* It is recommended that assistance be available when installing this fixture

2

1. Slip threaded end (B) of upright (2) into recessed hole (A) of canopy (1) - see **Drawing 1**.
2. Slip lockwasher (3) onto threaded end (B) of upright (2). Then thread on hex nut (4) - do not tighten at this time.
3. Repeat steps 1 and 2 for remaining uprights.
4. Slip cap (5) along wire and place on top of canopy (1).
5. Slip coupler (6) along wire and thread onto threaded tube (C) and tighten.
6. The diffuser (7) is attached by first removing the ball knob studs (8) from the cluster plate (D).
7. Place diffuser (7) onto top of cluster plate (D) and line up the holes.
8. Thread ball knob studs (7) back into cluster plate (D) to secure diffuser. Repeat with opposite diffuser panel.
9. Please refer to the hanging instruction sheet (I.S. 19) provided to hang this fixture. Then refer back to this sheet to complete fixture assembly

3

1. To install glass, set glass (9) into ring (10) - see **Drawing 1**.
2. Line up hole (F) in ring upright (G) with hole (E) in end of upright (2).
3. Slip threaded stud (11) through hole (F) in ring upright (G) and thread into hole (E) of upright (2).
4. Repeat steps 2 and 3 for the remaining uprights.
5. Tighten all hex nuts and ball knob studs at this time.
6. Fixture can now be lamped accordingly.

4.8.10

Drawing 1 - Flush Mount



Drawing 2 - Chain Hung



Drawing 3 - Post-Mount



SAFETY WARNING: READ WIRING AND GROUNDING INSTRUCTIONS (I.S. 18) AND ANY ADDITIONAL DIRECTIONS. TURN POWER SUPPLY OFF DURING INSTALLATION. IF NEW WIRING IS REQUIRED, CONSULT A QUALIFIED ELECTRICIAN OR LOCAL AUTHORITIES FOR CODE REQUIREMENTS.

wiring instructions

Indoor Fixtures

1. Connect positive supply wire **(A)** (typically black or the smooth, unmarked side of the two-conductor cord) to positive fixture lead **(B)** with appropriately sized twist on connector - see **Drawings 1 or 2**.
2. Connect negative supply wire **(C)** (typically white or the ribbed, marked side of the two-conductor cord) to negative fixture lead **(D)**.
3. Please refer to the **grounding instructions** below to complete all electrical connections.

Outdoor Fixtures

1. Connect positive supply wire **(A)** (typically black or the smooth unmarked side of the two-conductor cord) to positive fixture lead **(B)** with appropriately sized twist on connector - see **Drawings 2 or 3**.
2. Connect negative supply wire **(C)** (typically white or the ribbed, marked side of the two-conductor cord) to negative fixture lead **(D)**.
3. Cover open end of connectors with silicone sealant to form a watertight seal.
 - If installing a wall mount fixture, use caulk to seal gaps between the fixture mounting plate (backplate) and the wall. This will help prevent water from entering the outlet box. If the wall surface is lap siding, use caulk and a fixture mounting platform specially.
4. Please refer to the **grounding instructions** below to complete all electrical connections.

grounding instructions

Flush Mount Fixtures

For positive grounding in a 3-wire electrical system, fasten the fixture ground wire **(E)** (typically copper or green plastic coated) to the fixture mounting strap **(1)** with the ground screw **(2)** - see **Drawing 1**.

Note: On straps for screw supported fixtures, first install the two mounting screws in strap. Any remaining tapped hole may be used for the ground screw.

Chain Hung Fixtures

Loop fixture ground wire **(E)** (typically copper or green plastic coated) under the head of the ground screw **(2)** on fixture mounting strap **(1)** and connect to the loose end of the fixture ground wire directly to the ground wire of the building system with appropriately sized twist-on connectors - see **Drawing 2**.

Post-Mount Fixtures

Connect fixture ground wire **(E)** (typically copper or green plastic coated) to power supply ground with appropriately sized twist-on connector inside post. Cover open end of connector with silicone sealant to form a watertight seal - see **Drawing 3**.